

Packaging Information

Item		Single Box(1pc/box)		Packaging Unit		
Item Code	Item Description	Dimensions(mm) (LxWxH)	Gross Weight (kg)	Dimensions(mm) (LxWxH)	Gross Weight (kg)	Packing Qty (pcs/unit)
140056845	LEDspotRA-HJ 40W-3000-17D-WH-GP	184*184*160	1.1	570*384*344	13	12
140056846	LEDspotRA-HJ 40W-3000-24D-WH-GP	184*184*160	1.1	570*384*344	13	12
140056847	LEDspotRA-HJ 40W-3000-36D-WH-GP	184*184*160	1.1	570*384*344	13	12
140056848	LEDspotRA-HJ 40W-4000-17D-WH-GP	184*184*160	1.1	570*384*344	13	12
140056849	LEDspotRA-HJ 40W-4000-24D-WH-GP	184*184*160	1.1	570*384*344	13	12
140056850	LEDspotRA-HJ 40W-4000-36D-WH-GP	184*184*160	1.1	570*384*344	13	12
541003034010	LEDspotRA-HJ 10W-Dim-3000-24D-WH-GP	173*116*90	0.38	608*541208	11	30
541003034110	LEDspotRA-HJ 16W-Dim-3000-24D-WH-GP	150*122*100	0.42	620*508*224	13	32
541003034210	LEDspotRA-HJ 30W-Dim-3000-24D-WH-GP	158*158*125	0.73	652*492*274	18	24
541003034310	LEDspotRA-HJ 40W-Dim-3000-24D-WH-GP	184*184*160	1.1	570*384*344	13	12

Dimensional Drawing

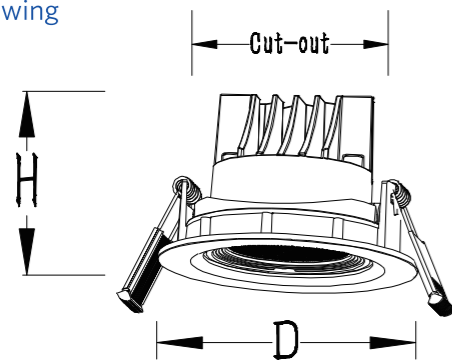

Type	H(mm)	D(mm)	C(mm)
LED SP-RA HJ10W	57	85	75
LED SP-RA HJ16W	82	116	100
LED SP-RA HJ 30W	109	138	125
LED SP-RA HJ 40W	140	170	150

Photometric Data

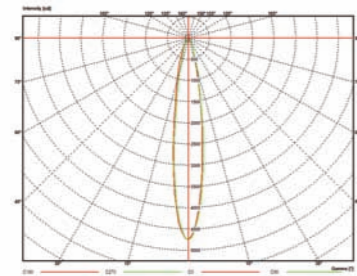

16D

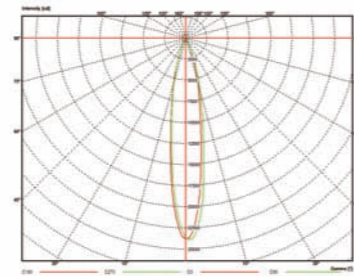

17D

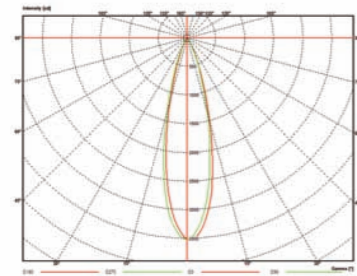

24D

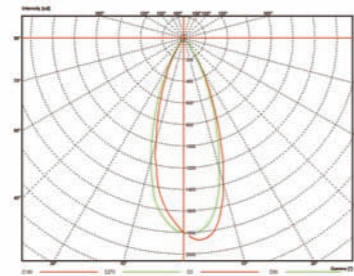

36D



LED Spotlight Grid HJ

Features

- New designed compound-eye lens
- Aluminum die-casting heat sink
- Multiple choices of beam angle & powers
- Horizontal rotate 355° vertical rotate 35°

Benefits

- Accurate light-shape control and uniform light distribution
- Superb heat control enables better efficiency
- Accommodate different display areas and applications
- Flexible adjustment for accent lighting

Application

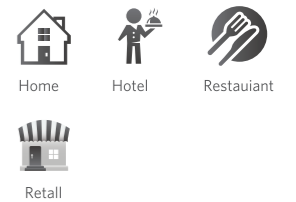

Specification

Item Code	Item Description	Power (W)	Power Factor	Lumen (lm)	Efficacy (lm/W)	Input Current (mA)	CRI	CTT (K)	Lifetime (L70B50)	MOQ (pcs)
140056821	LEDspotGR-HJ-1 10W-3000-24D-WH-GP	10	0.94	850	85	50	>80	3000	30000	300
140056851	LEDspotGR-HJ-1 10W-4000-24D-WH-GP	10	0.94	850	85	50	>80	4000	30000	300
140057400	LEDspotGR-HJ-1 10W-3000-24D-GY-GP	10	0.94	850	85	50	>80	3000	30000	300
140057401	LEDspotGR-HJ-1 10W-4000-24D-GY-GP	10	0.94	850	85	50	>80	4000	30000	300
140056852	LEDspotGR-HJ-2 20W-3000-24D-WH-GP	20	0.94	1700	85	100	>80	3000	30000	300
140056853	LEDspotGR-HJ-2 20W-4000-24D-WH-GP	20	0.94	1700	85	100	>80	4000	30000	300
140057402	LEDspotGR-HJ-2 20W-3000-24D-GY-GP	20	0.94	1700	85	100	>80	3000	30000	300
140057403	LEDspotGR-HJ-2 20W-4000-24D-GY-GP	20	0.94	1700	85	100	>80	4000	30000	300
140056854	LEDspotGR-HJ-1 20W-3000-24D-WH-GP	20	0.94	1800	90	90	>80	3000	30000	300
140056855	LEDspotGR-HJ-1 20W-4000-24D-WH-GP	20	0.94	1800	90	90	>80	4000	30000	300
140057404	LEDspotGR-HJ-1 20W-3000-24D-GY-GP	20	0.94	1800	90	90	>80	3000	30000	300
140057405	LEDspotGR-HJ-1 20W-4000-24D-GY-GP	20	0.94	1800	90	90	>80	4000	30000	300
140056856	LEDspotGR-HJ-2 40W-3000-24D-WH-GP	40	0.94	3600	90	180	>80	3000	30000	300
140056857	LEDspotGR-HJ-2 40W-4000-24D-WH-GP	40	0.94	3600	90	180	>80	4000	30000	300
140057406	LEDspotGR-HJ-2 40W-3000-24D-GY-GP	40	0.94	3600	90	180	>80	3000	30000	300
140057407	LEDspotGR-HJ-2 40W-4000-24D-GY-GP	40	0.94	3600	90	180	>80	4000	30000	300
140056858	LEDspotGR-HJ-1 30W-3000-24D-WH-GP	30	0.94	2800	93	140	>80	3000	30000	300
140056859	LEDspotGR-HJ-1 30W-4000-24D-WH-GP	30	0.94	2800	93	140	>80	4000	30000	300
140057408	LEDspotGR-HJ-1 30W-3000-24D-GY-GP	30	0.94	2800	93	140	>80	3000	30000	300
140057409	LEDspotGR-HJ-1 30W-4000-24D-GY-GP	30	0.94	2800	93	140	>80	4000	30000	300
140056860	LEDspotGR-HJ-2 60W-3000-24D-WH-GP	60	0.94	5600	93	280	>80	3000	30000	300
140056861	LEDspotGR-HJ-2 60W-4000-24D-WH-GP	60	0.94	5600	93	280	>80	4000	30000	300
140057410	LEDspotGR-HJ-2 60W-3000-24D-GY-GP	60	0.94	5600	93	280	>80	3000	30000	300
140057411	LEDspotGR-HJ-2 60W-4000-24D-GY-GP	60	0.94	5600	93	280	>80	4000	30000	300

Item Code	Item Description	Power (W)	Power Factor	Lumen (lm)	Efficacy (lm/W)	Input Current (mA)	CRI	CTT (K)	Lifetime (L70B50)	MOQ (pcs)
140056862	LEDspotGR-HJ-1 40W-3000-24D-WH-GP	40	0.94	4000	100	180	>80	3000	30000	300
140056863	LEDspotGR-HJ-1 40W-4000-24D-WH-GP	40	0.94	4000	100	180	>80	4000	30000	300
140057412	LEDspotGR-HJ-1 40W-3000-24D-GY-GP	40	0.94	4000	100	180	>80	3000	30000	300
140057413	LEDspotGR-HJ-1 40W-4000-24D-GY-GP	40	0.94	4000	100	180	>80	4000	30000	300
140056864	LEDspotGR-HJ-2 80W-3000-24D-WH-GP	80	0.94	8000	100	360	>80	3000	30000	300
140056865	LEDspotGR-HJ-2 80W-4000-24D-WH-GP	80	0.94	8000	100	360	>80	4000	30000	300
140057414	LEDspotGR-HJ-2 80W-3000-24D-GY-GP	80	0.94	8000	100	360	>80	3000	30000	300
140057415	LEDspotGR-HJ-2 80W-4000-24D-GY-GP	80	0.94	8000	100	360	>80	4000	30000	300

Technical Specifications	
On / Off Cycles	50,000
Colour Consistency (SDCM)	<6
Dimmable	No
Beam Angle °	24
Finishing Colour	White/Grey
IP	IP20
IK	IK02
Driver Integrated (Yes/No)	No
Glow Wire Test	650C
Driver Failure Rate	1% at 5000h
Weight (kg/pc)	0.51/0.88/1.02/1.86/1.62/2.93

Electrical Supply	
Frequency (Hz)	50/60
Voltage (V)	220-240
AC/DC	AC
Mechanical Properties	
Housing Material	Aluminum+PC
Optical Material	PC
Application Conditions	
Operating Temperature	-25-50°C
Application Temperature	25°C
Storage Environment	-25-50°C

CE CB

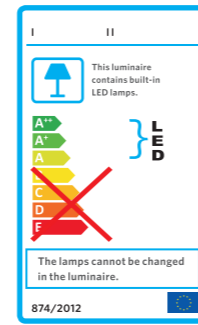

Packaging Information

Item		Single Box(1pc/box)		Packaging Unit	
Item Code	Item Description	Dimensions(mm) (LxWxH)	Gross Weight (kg)	Dimensions(mm) (LxWxH)	Packaging Qty (pcs/unit)
140057410	LEDspotGR-HJ-2 60W-3000-24D-GY-GP	316*188*151	2.375	402*334*346	4
140057411	LEDspotGR-HJ-2 60W-4000-24D-GY-GP	316*188*151	2.375	402*334*346	4
140056862	LEDspotGR-HJ-1 40W-3000-24D-WH-GP	224*222*180	1.93	470*470*402	8
140056863	LEDspotGR-HJ-1 40W-4000-24D-WH-GP	224*222*180	1.93	470*470*402	8
140057412	LEDspotGR-HJ-1 40W-3000-24D-GY-GP	224*222*180	1.93	470*470*402	8
140057413	LEDspotGR-HJ-1 40W-4000-24D-GY-GP	224*222*180	1.93	470*470*402	8
140056864	LEDspotGR-HJ-2 80W-3000-24D-WH-GP	380*222*180	3.63	470*398*402	4
140056865	LEDspotGR-HJ-2 80W-4000-24D-WH-GP	380*222*180	3.63	470*398*402	4
140057414	LEDspotGR-HJ-2 80W-3000-24D-GY-GP	380*222*180	3.63	470*398*402	4
140057415	LEDspotGR-HJ-2 80W-4000-24D-GY-GP	380*222*180	3.63	470*398*402	4

Dimensional Drawing

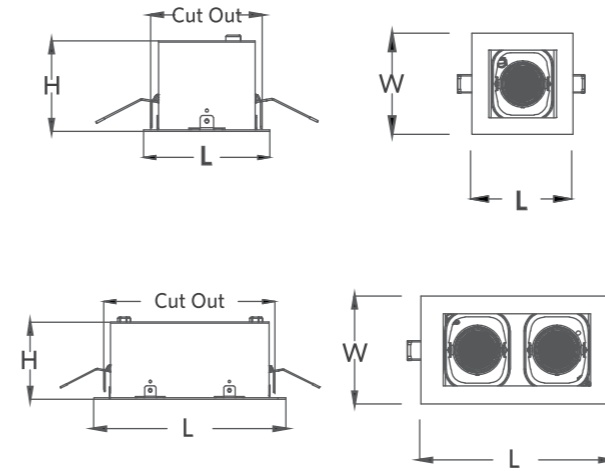

Model	L (mm)	W (mm)	H (mm)	Cut Out (mm)
LED SP-GR HJ-110W	115	115	83	95*95
LED SP-GR HJ-2 20W	205	115	83	175*95
LED SP-GR HJ-1 20W	147	147	117	130*130
LED SP-GR HJ-2 40W	264	147	117	255*130
LED SP-GR HJ-1 30W	147	147	117	130*130
LED SP-GR HJ-2 60W	264	147	117	255*130
LED SP-GR HJ-1 40W	185	185	145	165*165
LED SP-GR HJ-2 80W	340	185	145	320*165

Packaging Information

Item		Single Box(1pc/box)		Packaging Unit	
Item Code	Item Description	Dimensions(mm) (LxWxH)	Gross Weight (kg)	Dimensions(mm) (LxWxH)	Packaging Qty (pcs/unit)
140056821	LEDspotGR-HJ-1 10W-3000-24D-WH-GP	172*170*115	0.651	540*358*256	12
140056851	LEDspotGR-HJ-1 10W-4000-24D-WH-GP	172*170*115	0.651	540*358*256	12
140057400	LEDspotGR-HJ-1 10W-3000-24D-GY-GP	172*170*115	0.651	540*358*256	12
140057401	LEDspotGR-HJ-1 10W-4000-24D-GY-GP	172*170*115	0.651	540*358*256	12
140056852	LEDspotGR-HJ-2 20W-3000-24D-WH-GP	250*172*115	1.044	514*358*256	8
140056853	LEDspotGR-HJ-2 20W-4000-24D-WH-GP	250*172*115	1.044	514*358*256	8
140057402	LEDspotGR-HJ-2 20W-3000-24D-GY-GP	250*172*115	1.044	514*358*256	8
140057403	LEDspotGR-HJ-2 20W-4000-24D-GY-GP	250*172*115	1.044	514*358*256	8
140056854	LEDspotGR-HJ-1 20W-3000-24D-WH-GP	190*188*151	1.334	402*402*346	8
140056855	LEDspotGR-HJ-1 20W-4000-24D-WH-GP	190*188*151	1.334	402*402*346	8
140057404	LEDspotGR-HJ-1 20W-3000-24D-GY-GP	190*188*151	1.334	402*402*346	8
140057405	LEDspotGR-HJ-1 20W-4000-24D-GY-GP	190*188*151	1.334	402*402*346	8
140056856	LEDspotGR-HJ-2 40W-3000-24D-WH-GP	316*188*151	2.375	402*334*346	4
140056857	LEDspotGR-HJ-2 40W-4000-24D-WH-GP	316*188*151	2.375	402*334*346	4
140057406	LEDspotGR-HJ-2 40W-3000-24D-GY-GP	316*188*151	2.375	402*334*346	4
140057407	LEDspotGR-HJ-2 40W-4000-24D-GY-GP	316*188*151	2.375	402*334*346	4
140056858	LEDspotGR-HJ-1 30W-3000-24D-WH-GP	190*188*151	1.334	402*402*346	8
140056859	LEDspotGR-HJ-1 30W-4000-24D-WH-GP	190*188*151	1.334	402*402*346	8
140057408	LEDspotGR-HJ-1 30W-3000-24D-GY-GP	190*188*151	1.334	402*402*346	8
140057409	LEDspotGR-HJ-1 30W-4000-24D-GY-GP	190*188*151	1.334	402*402*346	8
140056860	LEDspotGR-HJ-2 60W-3000-24D-WH-GP	316*188*151	2.375	402*334*346	4
140056861	LEDspotGR-HJ-2 60W-4000-24D-WH-GP	316*188*151	2.375	402*334*346	4

Photometric Data

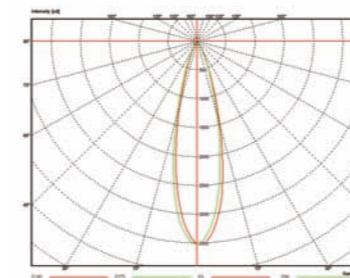

24D