

## LED Spotlight HJ G2

### Features

- Multiple dimming modes
- New designed compound-eye lens
- Aluminum die-casting heat sink
- Multiple choices of beam angle powers
- Horizontal rotate 355°, vertical rotate 35°

### Benefits

- Tune light intensity to suit you environment and connect smart system, smart your life
- Accurate light-shape control and uniform light distribution
- Superb heat control enables better efficiency
- Accommodate different display areas and applications
- Flexible adjustment for accent lighting

### Application



Home



Hotel



Restaurant



Retail

### Specification

Item Code	Item Description	Power (W)	Power Factor	Lumen (lm)	Efficacy (lm/W)	Beam Angle(°)	CIR	Input Current (mA)	CCT(K)	Lifetime (L70B50)	MOQ (pcs)
541003181910	LEDSpotRA-HJII 10W-3000-16°-WH	10	0.9	950	95	16°	>80	54	3000	30000	300
541003182010	LEDSpotRA-HJII 10W-3000-24°-WH	10	0.9	950	95	24°	>80	54	3000	30000	300
541003182110	LEDSpotRA-HJII 10W-3000-36°-WH	10	0.9	950	95	36°	>80	54	3000	30000	300
541003182210	LEDSpotRA-HJII 10W-4000-16°-WH	10	0.9	1000	100	16°	>80	54	4000	30000	300
541003182310	LEDSpotRA-HJII 10W-4000-24°-WH	10	0.9	1000	100	24°	>80	54	4000	30000	300
541003182410	LEDSpotRA-HJII 10W-4000-36°-WH	10	0.9	1000	100	36°	>80	54	4000	30000	300
541003182510	LEDSpotRA-HJII 16W-3000-16°-WH	16	0.9	1520	95	16°	>80	80	3000	30000	300
541003182610	LEDSpotRA-HJII 16W-3000-24°-WH	16	0.9	1520	95	24°	>80	80	3000	30000	300
541003182710	LEDSpotRA-HJII 16W-3000-36°-WH	16	0.9	1520	95	36°	>80	80	3000	30000	300
541003182810	LEDSpotRA-HJII 16W-4000-16°-WH	16	0.9	1600	100	16°	>80	80	4000	30000	300
541003182910	LEDSpotRA-HJII 16W-4000-24°-WH	16	0.9	1600	100	24°	>80	80	4000	30000	300
541003183010	LEDSpotRA-HJII 16W-4000-36°-WH	16	0.9	1600	100	36°	>80	80	4000	30000	300
541003183110	LEDSpotRA-HJII 30W-3000-16°-WH	30	0.9	3000	100	16°	>80	140	3000	30000	300
541003183210	LEDSpotRA-HJII 30W-3000-24°-WH	30	0.9	3000	100	24°	>80	140	3000	30000	300
541003183310	LEDSpotRA-HJII 30W-3000-36°-WH	30	0.9	3000	100	36°	>80	140	3000	30000	300
541003183410	LEDSpotRA-HJII 30W-4000-16°-WH	30	0.9	3000	100	16°	>80	140	4000	30000	300
541003183510	LEDSpotRA-HJII 30W-4000-24°-WH	30	0.9	3000	100	24°	>80	140	4000	30000	300
541003183610	LEDSpotRA-HJII 30W-4000-36°-WH	30	0.9	3000	100	36°	>80	140	4000	30000	300
541003183710	LEDSpotRA-HJII 40W-3000-16°-WH	40	0.9	4000	100	16°	>80	180	3000	30000	300
541003183810	LEDSpotRA-HJII 40W-3000-24°-WH	40	0.9	4000	100	24°	>80	180	3000	30000	300
541003183910	LEDSpotRA-HJII 40W-3000-36°-WH	40	0.9	4000	100	36°	>80	180	3000	30000	300
541003184010	LEDSpotRA-HJII 40W-4000-16°-WH	40	0.9	4000	100	16°	>80	180	4000	30000	300
541003184110	LEDSpotRA-HJII 40W-4000-24°-WH	40	0.9	4000	100	24°	>80	180	4000	30000	300
541003184210	LEDSpotRA-HJII 40W-4000-36°-WH	40	0.9	4000	100	36°	>80	180	4000	30000	300

Item Code	Item Description	Power (W)	Power Factor	Lumen (lm)	Efficacy (lm/W)	Beam Angle(°)	CIR	Input Current (mA)	CCT(K)	Lifetime (L70B50)	MOQ (pcs)
541003184510	LEDspotRA-HJII 10W-Dim-3000-16°-WH	10	0.9	950	95	16°	>80	54	3000	30000	300
541003184610	LEDspotRA-HJII 10W-Dim-3000-24°-WH	10	0.9	950	95	24°	>80	54	3000	30000	300
541003184710	LEDspotRA-HJII 10W-Dim-3000-36°-WH	10	0.9	950	95	36°	>80	54	3000	30000	300
541003184810	LEDspotRA-HJII 10W-Dim-4000-16°-WH	10	0.9	1000	100	16°	>80	54	4000	30000	300
541003184910	LEDspotRA-HJII 10W-Dim-4000-24°-WH	10	0.9	1000	100	24°	>80	54	4000	30000	300
541003185010	LEDspotRA-HJII 10W-Dim-4000-36°-WH	10	0.9	1000	100	36°	>80	54	4000	30000	300
541003185110	LEDspotRA-HJII 16W-Dim-3000-16°-WH	16	0.9	1520	95	16°	>80	80	3000	30000	300
541003185210	LEDspotRA-HJII 16W-Dim-3000-24°-WH	16	0.9	1520	95	24°	>80	80	3000	30000	300
541003185310	LEDspotRA-HJII 16W-Dim-3000-36°-WH	16	0.9	1520	95	36°	>80	80	3000	30000	300
541003185410	LEDspotRA-HJII 16W-Dim-4000-16°-WH	16	0.9	1600	100	16°	>80	80	4000	30000	300
541003185510	LEDspotRA-HJII 16W-Dim-4000-24°-WH	16	0.9	1600	100	24°	>80	80	4000	30000	300
541003185610	LEDspotRA-HJII 16W-Dim-4000-36°-WH	16	0.9	1600	100	36°	>80	80	4000	30000	300
541003185710	LEDspotRA-HJII 30W-Dim-3000-16°-WH	30	0.9	3000	100	16°	>80	140	3000	30000	300
541003185810	LEDspotRA-HJII 30W-Dim-3000-24°-WH	30	0.9	3000	100	24°	>80	140	3000	30000	300
541003185910	LEDspotRA-HJII 30W-Dim-3000-36°-WH	30	0.9	3000	100	36°	>80	140	3000	30000	300
541003186010	LEDspotRA-HJII 30W-Dim-4000-16°-WH	30	0.9	3000	100	16°	>80	140	4000	30000	300
541003186110	LEDspotRA-HJII 30W-Dim-4000-24°-WH	30	0.9	3000	100	24°	>80	140	4000	30000	300
541003186210	LEDspotRA-HJII 30W-Dim-4000-36°-WH	30	0.9	3000	100	36°	>80	140	4000	30000	300
541003186310	LEDspotRA-HJII 40W-Dim-3000-16°-WH	40	0.9	4000	100	16°	>80	180	3000	30000	300
541003186410	LEDspotRA-HJII 40W-Dim-3000-24°-WH	40	0.9	4000	100	24°	>80	180	3000	30000	300
541003186510	LEDspotRA-HJII 40W-Dim-3000-36°-WH	40	0.9	4000	100	36°	>80	180	3000	30000	300
541003186610	LEDspotRA-HJII 40W-Dim-4000-16°-WH	40	0.9	4000	100	16°	>80	180	4000	30000	300
541003186710	LEDspotRA-HJII 40W-Dim-4000-24°-WH	40	0.9	4000	100	24°	>80	180	4000	30000	300
541003186810	LEDspotRA-HJII 40W-Dim-4000-36°-WH	40	0.9	4000	100	36°	>80	180	4000	30000	300
821098000110	Dimming module-non isolation-1-10V-V1	-	-	-	-	-	-	-	-	-	100
821098000210	Dimming module-non isolation-DALI-V1	-	-	-	-	-	-	-	-	-	100
821098000310	Dimming module-non isolation-BLE-V1	-	-	-	-	-	-	-	-	-	100

Technical Specifications	
CRI	>80
Colour Consistency (SDCM)	<6
Dimmable	Yes
Housing Colour	White
IP	IP20
IK	IK02
Driver integrated (Yes/No)	No
Glow wire test	650°
Driver failure rate	1% at 5000h
Weight (pc/kg)	0.21/0.35/0.65/0.9 0.31/0.45/0.74/0.98

Electrical Supply	
Frequency (Hz)	50/60
Voltage (V)	220-240
AC/DC	AC

Mechanical Properties	
Housing Material	Aluminum
Optical Material	pc

Application Conditions	
Operating Temperature	-25-50°C
Application Temperature	25°C
Storage Environment	-25-50°C

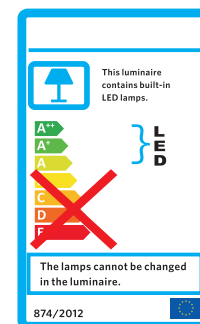

## Packaging Information

Item		Single Box(1pc/box)		Outer Box		
Item Code	Item Description	Dimensions(mm) (LxWxH)	Gross Weight (kg)	Dimensions(mm) (LxWxH)	Gross Weight (kg)	Packing Qty (pcs/CTN)
541003181910	LEDSpotRA-HJII 10W-3000-16°-WH	95*95*90	0.266	505*305*205	7.98	30
541003182010	LEDSpotRA-HJII 10W-3000-24°-WH	95*95*90	0.266	505*305*205	7.98	30
541003182110	LEDSpotRA-HJII 10W-3000-36°-WH	95*95*90	0.266	505*305*205	7.98	30
541003182210	LEDSpotRA-HJII 10W-4000-16°-WH	95*95*90	0.266	505*305*205	7.98	30
541003182310	LEDSpotRA-HJII 10W-4000-24°-WH	95*95*90	0.266	505*305*205	7.98	30
541003182410	LEDSpotRA-HJII 10W-4000-36°-WH	95*95*90	0.266	505*305*205	7.98	30
541003182510	LEDSpotRA-HJII 16W-3000-16°-WH	120*120*110	0.425	500*255*470	13.6	32
541003182610	LEDSpotRA-HJII 16W-3000-24°-WH	120*120*110	0.425	500*255*470	13.6	32
541003182710	LEDSpotRA-HJII 16W-3000-36°-WH	120*120*110	0.425	500*255*470	13.6	32
541003182810	LEDSpotRA-HJII 16W-4000-16°-WH	120*120*110	0.425	500*255*470	13.6	32
541003182910	LEDSpotRA-HJII 16W-4000-24°-WH	120*120*110	0.425	500*255*470	13.6	32
541003183010	LEDSpotRA-HJII 16W-4000-36°-WH	120*120*110	0.425	500*255*470	13.6	32
541003183110	LEDSpotRA-HJII 30W-3000-16°-WH	158*158*125	0.777	652*492*274	18.648	24
541003183210	LEDSpotRA-HJII 30W-3000-24°-WH	158*158*125	0.777	652*492*274	18.648	24
541003183310	LEDSpotRA-HJII 30W-3000-36°-WH	158*158*125	0.777	652*492*274	18.648	24
541003183410	LEDSpotRA-HJII 30W-4000-16°-WH	158*158*125	0.777	652*492*274	18.648	24
541003183510	LEDSpotRA-HJII 30W-4000-24°-WH	158*158*125	0.777	652*492*274	18.648	24
541003183610	LEDSpotRA-HJII 30W-4000-36°-WH	158*158*125	0.777	652*492*274	18.648	24
541003183710	LEDSpotRA-HJII 40W-3000-16°-WH	184*184*160	1.037	570*384*344	12.444	12
541003183810	LEDSpotRA-HJII 40W-3000-24°-WH	184*184*160	1.037	570*384*344	12.444	12
541003183910	LEDSpotRA-HJII 40W-3000-36°-WH	184*184*160	1.037	570*384*344	12.444	12
541003184010	LEDSpotRA-HJII 40W-4000-16°-WH	184*184*160	1.037	570*384*344	12.444	12
541003184110	LEDSpotRA-HJII 40W-4000-24°-WH	184*184*160	1.037	570*384*344	12.444	12
541003184210	LEDSpotRA-HJII 40W-4000-36°-WH	184*184*160	1.037	570*384*344	12.444	12
541003184510	LEDSpotRA-HJII 10W-Dim-3000-16°-WH	194*94*120	0.414	495*405*265	8.28	20
541003184610	LEDSpotRA-HJII 10W-Dim-3000-24°-WH	194*94*120	0.414	495*405*265	8.28	20
541003184710	LEDSpotRA-HJII 10W-Dim-3000-36°-WH	194*94*120	0.414	495*405*265	8.28	20
541003184810	LEDSpotRA-HJII 10W-Dim-4000-16°-WH	194*94*120	0.414	495*405*265	8.28	20
541003184910	LEDSpotRA-HJII 10W-Dim-4000-24°-WH	194*94*120	0.414	495*405*265	8.28	20
541003185010	LEDSpotRA-HJII 10W-Dim-4000-36°-WH	194*94*120	0.414	495*405*265	8.28	20
541003185110	LEDSpotRA-HJII 16W-Dim-3000-16°-WH	194*146*100	0.57	460*405*225	6.84	12
541003185210	LEDSpotRA-HJII 16W-Dim-3000-24°-WH	194*146*100	0.57	460*405*225	6.84	12
541003185310	LEDSpotRA-HJII 16W-Dim-3000-36°-WH	194*146*100	0.57	460*405*225	6.84	12
541003185410	LEDSpotRA-HJII 16W-Dim-4000-16°-WH	194*146*100	0.57	460*405*225	6.84	12
541003185510	LEDSpotRA-HJII 16W-Dim-4000-24°-WH	194*146*100	0.57	460*405*225	6.84	12
541003185610	LEDSpotRA-HJII 16W-Dim-4000-36°-WH	194*146*100	0.57	460*405*225	6.84	12
541003185710	LEDSpotRA-HJII 30W-Dim-3000-16°-WH	196*170*125	0.883	530*410*275	10.596	12
541003185810	LEDSpotRA-HJII 30W-Dim-3000-24°-WH	196*170*125	0.883	530*410*275	10.596	12
541003185910	LEDSpotRA-HJII 30W-Dim-3000-36°-WH	196*170*125	0.883	530*410*275	10.596	12
541003186010	LEDSpotRA-HJII 30W-Dim-4000-16°-WH	196*170*125	0.883	530*410*275	10.596	12

Item		Single Box(1pc/box)		Outer Box		
Item Code	Item Description	Dimensions(mm) (LxWxH)	Gross Weight (kg)	Dimensions(mm) (LxWxH)	Gross Weight (kg)	Packing Qty (pcs/CTN)
541003186110	LEDspotRA-HJII 30W-Dim-4000-24°-WH	196*170*125	0.883	530*410*275	10.596	12
541003186210	LEDspotRA-HJII 30W-Dim-4000-36°-WH	196*170*125	0.883	530*410*275	10.596	12
541003186310	LEDspotRA-HJII 40W-Dim-3000-16°-WH	196*196*162	1.165	410*410*350	9.32	8
541003186410	LEDspotRA-HJII 40W-Dim-3000-24°-WH	196*196*162	1.165	410*410*350	9.32	8
541003186510	LEDspotRA-HJII 40W-Dim-3000-36°-WH	196*196*162	1.165	410*410*350	9.32	8
541003186610	LEDspotRA-HJII 40W-Dim-4000-16°-WH	196*196*162	1.165	410*410*350	9.32	8
541003186710	LEDspotRA-HJII 40W-Dim-4000-24°-WH	196*196*162	1.165	410*410*350	9.32	8
541003186810	LEDspotRA-HJII 40W-Dim-4000-36°-WH	196*196*162	1.165	410*410*350	9.32	8
821098000110	Dimming module-non isolation-1-10V-V1	-	0.058	255*135*105	1.16	20
821098000210	Dimming module-non isolation-DALI-V1	-	0.058	255*135*105	1.16	20
821098000310	Dimming module-non isolation-BLE-V1	-	0.058	255*135*105	1.16	20

## Dimensional Drawing

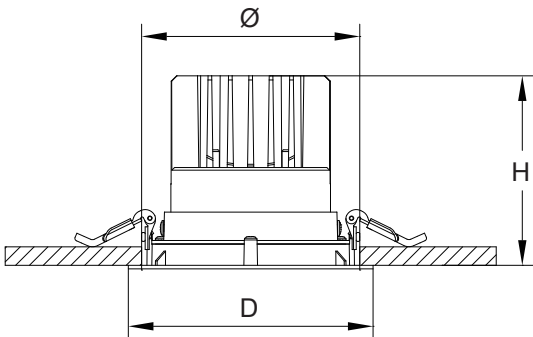

Type	D(mm)	$\Phi$ (mm)	H(mm)
LED SP-RA HJII 10W	85	75	57
LED SP-RA HJII 16W	116	100	82
LED SP-RA HJII 30W	138	125	109
LED SP-RA HJII 40W	170	150	137

# Photometric Data

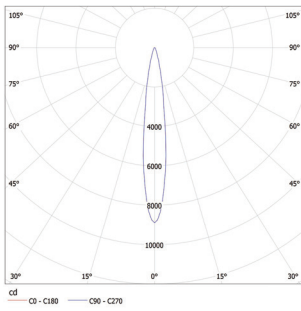

10W 16D

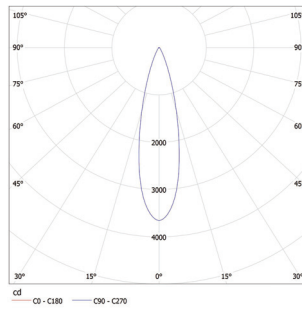

10W 24D

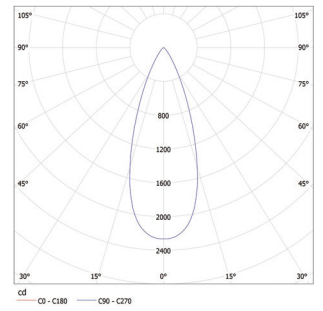

10W 36D

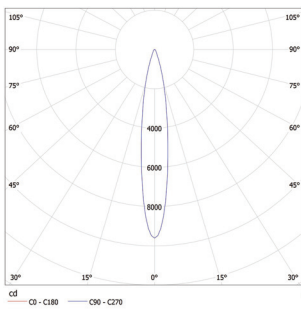

16W 16D

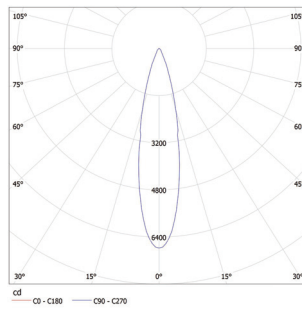

16W 24D

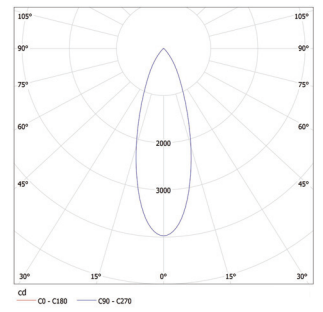

16W 36D

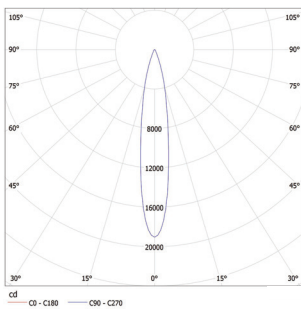

30W 16D

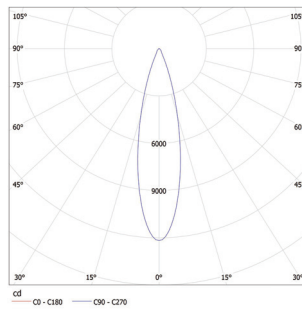

30W 24D

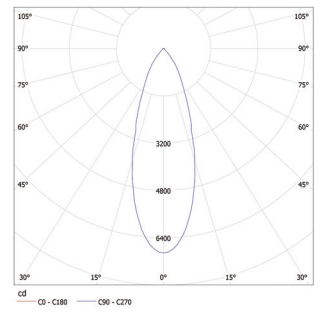

30W 36D

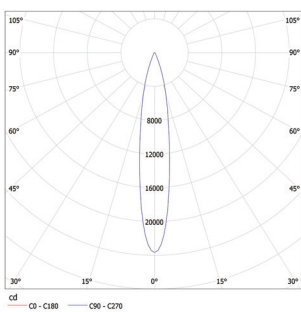

40W 16D

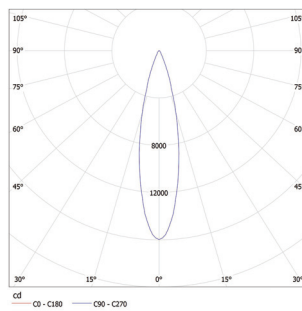

40W 24D

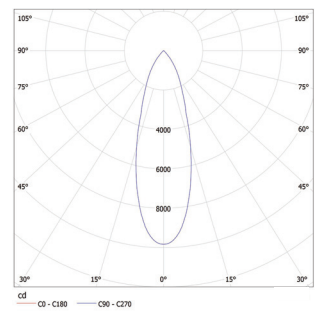

40W 36D

## OPPLE SHANGHAI OFFICE

Building V3, The Mixc, 1799 Wuzhong Road,  
Minhang District, Shanghai, China

ZIP: 201103

T +86 21 3855 0000

E intersales@opple.com

[WWW.OPPLE.COM/EN](http://WWW.OPPLE.COM/EN)