

DS CODE:  
**900107**

## LS Simple™ Cabling Solution

### LS Rack accessories

#### Part Numbers

Item	Description	Dimension (H * W * D mm)	Part Numbers
Entry Panel	Entry Panel, 4 entry holes 1U	43 * 482 * 10	LS-EN-1U-EX
	Entry Brush 1U	43 * 482 * 10	LS-EB-1U-EX
Blank Panel	Blank panel 1U	43 * 482 * 10	LS-BK-1U-EX
	Blank panel 2U	88 * 482 * 100	LS-BK-2U-EX
	Blank panel 3U	132 * 482 * 100	LS-BK-3U-EX
Ring-run Panel	5 Ring-run 1U	43 * 482 * 78	LS-RR-1U-EX
	5 Ring-run 2U	88 * 482 * 77	LS-RR-2U-EX
Shelf	Black color, 19" 2 points holding	-	LS-SF-300-BK-EX
	Black color, 19" 4 points holding	D750mm	LS-SF-750-BK-EX
	Black color, 19" 4 points holding	D800mm	LS-SF-800-BK-EX
	Black color, 19" 4 points holding	D1000mm	LS-SF-1000-BK-EX
Bracket	110 Bracket 1U	43 * 482 * 10	LS-110B-1U-EX
	110 Bracket 2U	88 * 482 * 10	LS-110B-2U-EX
	110 Bracket 4U	173 * 482 * 10	LS-110B-4U-EX
	Supplement cable bracket OD6mm	12 * 482 * 6	LS-RC-EX
HCM (Horizontal Cable Management)	Finger type HCM (Horizontal Cable Management) 1U	44 * 482 * 85	LS-HCM-1U-EX
	Finger type HCM (Horizontal Cable Management) 2U	88 * 482 * 85	LS-HCM-2U-EX
	Inside, Finger type HCM (Horizontal Cable management) 2U	89 * 482 * 154	LS-HCML-2U-EX
Power strip	Power Unit (220V-8Way)	-	LS-PU8-A-EX
	Power Unit (16A-8WAY)	Universal type	LS-PU8-B-EX
	Power Unit (30A-8WAY)-30A	Universal type	LS-PU8-C-EX

\* If additional unit or option is needed, Please contact to LS .([www.lssimple.com](http://www.lssimple.com))

DS CODE:  
**900107**

## LS Simple™ Cabling Solution

### LS-EN-1U-EX

#### Drawing

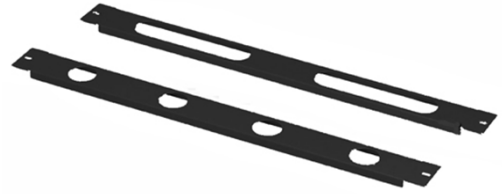

Description	Dimension (H * W * D mm)	Part Numbers
Entry Panel, 4 entry holes , 1U	43 * 482 * 10	LS-EN-1U-EX

[mm]

Color: Black

### LS-EB-1U-EX

#### Drawing

Description	Dimension (H * W * D mm)	Part Numbers
Entry Brush Panel, 4 entry holes, 1U	43 * 482 * 10	LS-EB-1U-EX

[mm]

Color: Black

DS CODE:  
**900107**

## LS Simple™ Cabling Solution

### LS-BK-1U-EX

#### Drawing



Description	Dimension (H * W * D mm)	Part Numbers
Blank Panel 1U	43 * 482 * 10	LS-BK-1U-EX

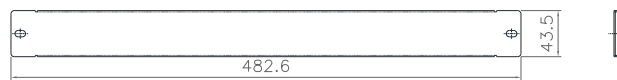

[mm]

Color: Black

### LS-BK-2U-EX

#### Drawing

Description	Dimension (H * W * D mm)	Part Numbers
Blank Panel 2U	88 * 482 * 100	LS-BK-2U-EX

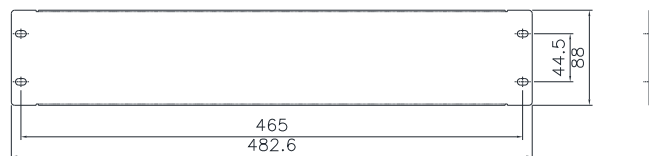

[mm]

Color: Black

### LS-BK-3U-EX

#### Drawing

Description	Dimension (H * W * D mm)	Part Numbers
Blank Panel 3U	132 * 482 * 100	LS-BK-3U-EX

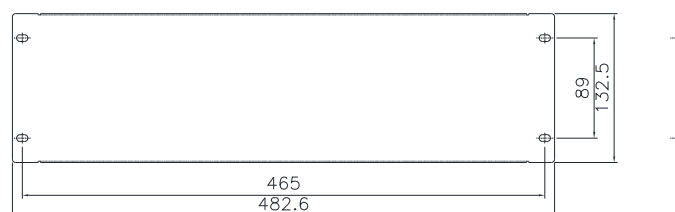

[mm]

Color: Black

DS CODE:  
**900107**

## LS Simple™ Cabling Solution

### LS-RR-1U-EX

Drawing



Description	Dimension (H * W * D mm)	Part Numbers
5 Ring run 1U	43 * 482 * 78	LS-RR-1U-EX

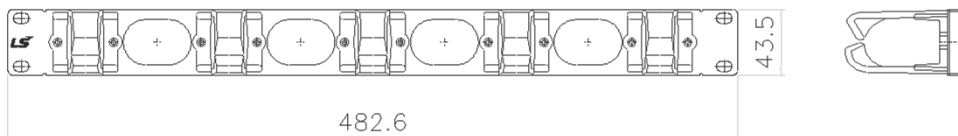
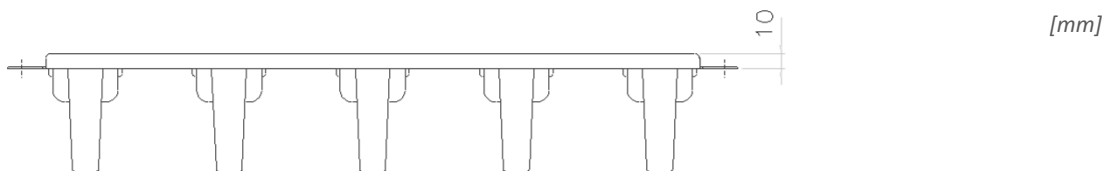

Color: Black

### LS-RR-2U-EX

Drawing

Description	Dimension (H * W * D mm)	Part Numbers
5 Ring run 2U	88 * 482 * 77	LS-RR-2U-EX

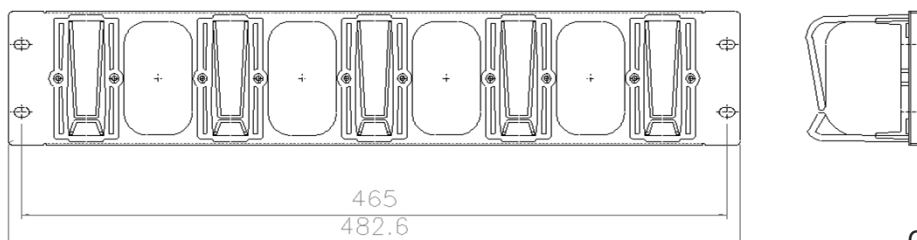

Color: Black

DS CODE:  
**900107**

## LS Simple™ Cabling Solution

### LS-SF-300-BK-EX

#### Drawing

Description	Dimension (H * W * D mm)	Part Numbers
Shelf Black color, 19" 2 points holding	44.5 * 483 * 300	LS-SF-300-BK-EX

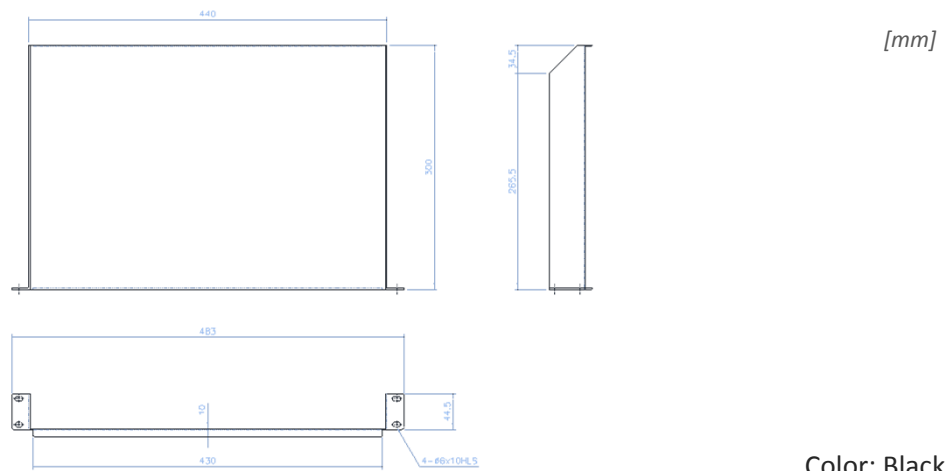

Color: Black

### LS-SF-750-BK-EX

#### Drawing

Description	Dimension (H * W * D mm)	Part Numbers
Shelf Black color, 19" 4 points holding	D750mm	LS-SF-750-BK-EX

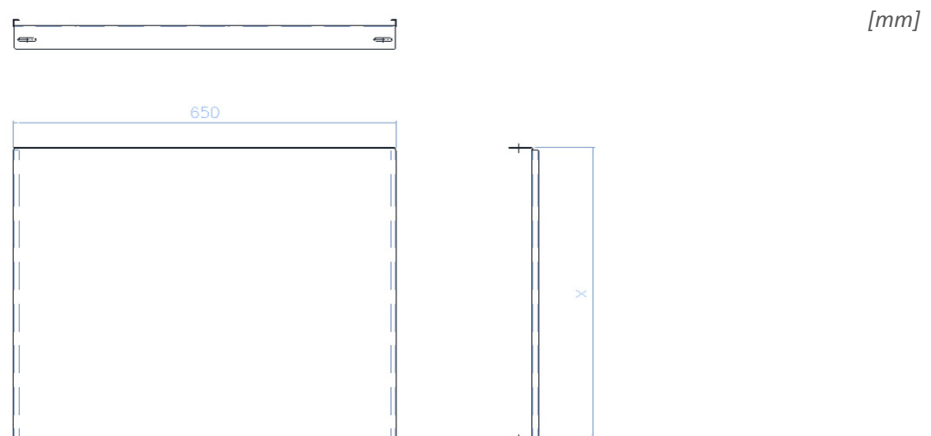

Color: Black

DS CODE:  
**900107**

## LS Simple™ Cabling Solution

### LS-SF-800-BK-EX

#### Drawing

Description	Dimension (H * W * D mm)	Part Numbers
Shelf Black color, 19" 4 points holding	D800mm	LS-SF-800-BK-EX



[mm]



Color: Black

### LS-SF-1000-BK-EX

#### Drawing

Description	Dimension (H * W * D mm)	Part Numbers
Shelf Black color, 19" 4 points holding	D1000mm	LS-SF-1000-BK-EX



[mm]



Color: Black

DS CODE:  
**900107**

## LS Simple™ Cabling Solution

### LS-110B-1U-EX

#### Drawing

Description	Dimension (H * W * D mm)	Part Numbers
110 Bracket 1U	43*482*10	LS-110B-1U-EX

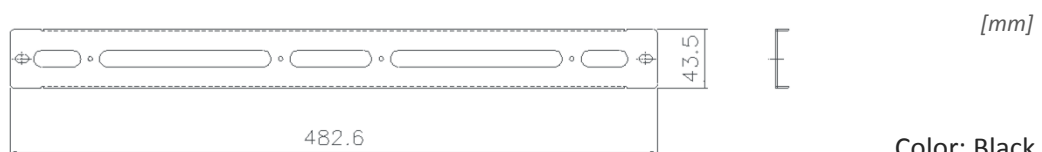

### LS-110B-2U-EX

#### Drawing

Description	Dimension (H * W * D mm)	Part Numbers
110 Bracket 2U	88 * 482 * 10	LS-110B-2U-EX

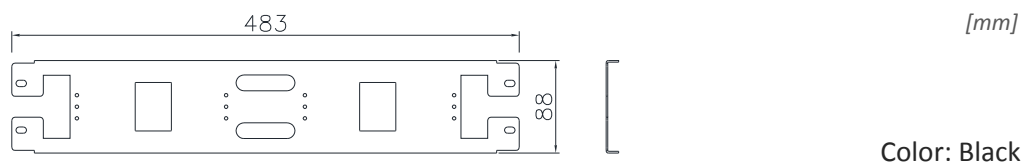

### LS-110B-4U-EX

#### Drawing

Description	Dimension (H * W * D mm)	Part Numbers
110 Bracket 4U	173 * 482 * 10	LS-110B-4U-EX

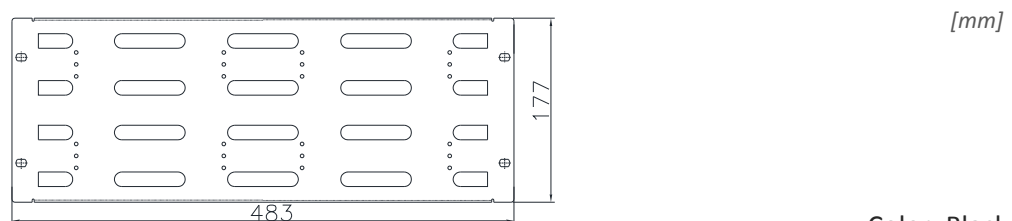

DS CODE:  
**900107**

## LS Simple™ Cabling Solution

### LS-RC-EX

#### Drawing

Description	Dimension (H * W * D mm)	Part Numbers
Supplement Cable Bracket OD6mm	12 * 482 * 6	LS-RC-EX

[mm]

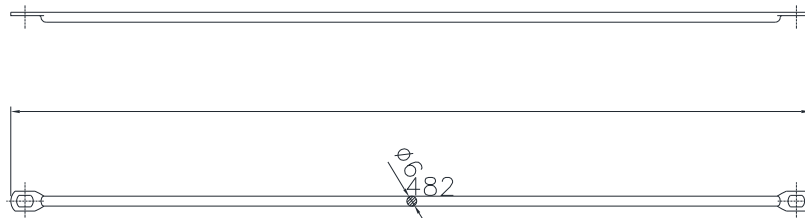



DS CODE:  
**900107**

## LS Simple™ Cabling Solution

### LS-HCM-1U-EX

#### Drawing

Description	Dimension (H * W * D mm)	Part Numbers
Finger type HCM (Horizontal Cable Management), 1U	44 * 482 * 85	LS-HCM-1U-EX



[mm]

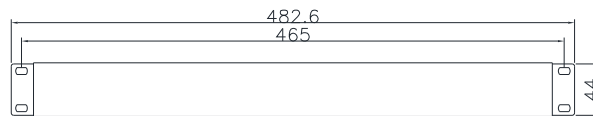
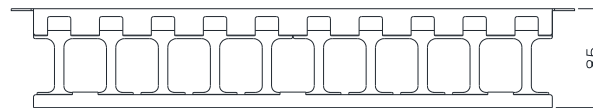

Color: Black

### LS-HCM-2U-EX

#### Drawing

Description	Dimension (H * W * D mm)	Part Numbers
Finger type HCM (Horizontal Cable Management), 2U	88 * 482 * 85	LS-HCM-2U-EX



[mm]

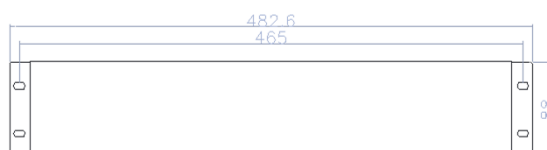
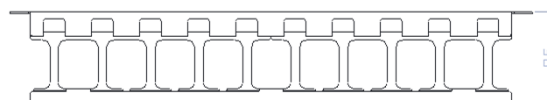

Color: Black

DS CODE:

# 900107

## LS Simple™ Cabling Solution

### LS-HCML-2U-EX

#### Drawing

Description	Dimension (H * W * D mm)	Part Numbers
Inside, Finger type HCM (Horizontal Cable management), 2U	89 * 482 * 154	LS-HCML-2U-EX

[mm]

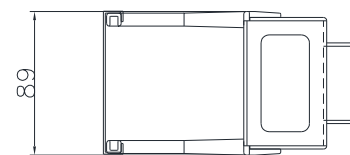
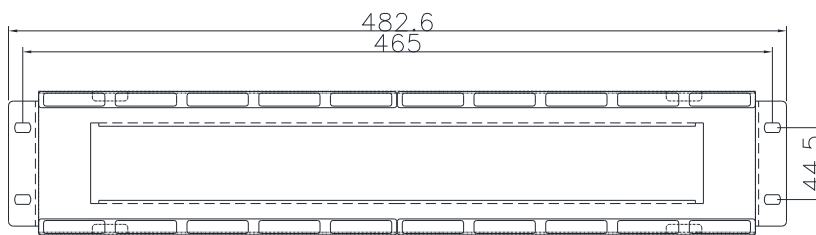
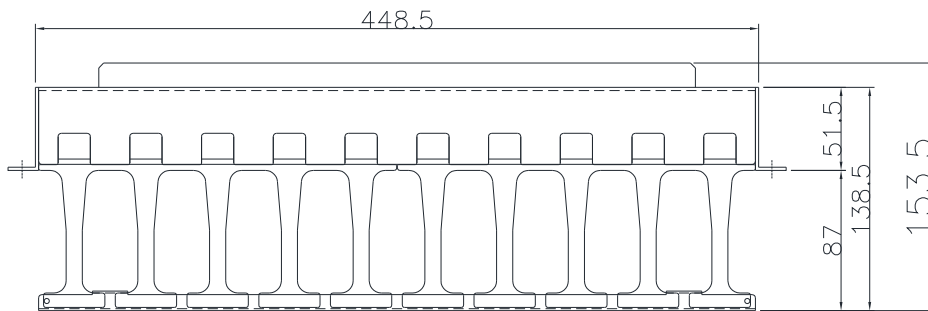

Color: Black

DS CODE:  
**900107**

## LS Simple™ Cabling Solution

### LS-PU8-A-EX

#### ➤ Drawing

Description	Part Numbers
Power Unit (220V-8Way)	LS-PU8-A-EX

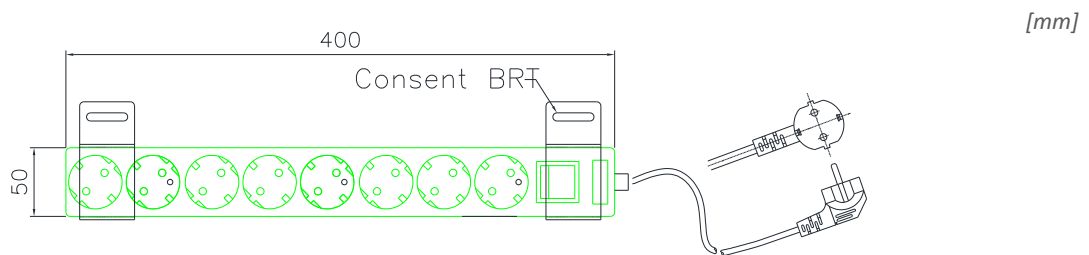

### LS-PU8-B-EX

#### ➤ Drawing

Description	Part Numbers
Power Unit (16A-8WAY), Universal type	LS-PU8-B-EX

[mm]

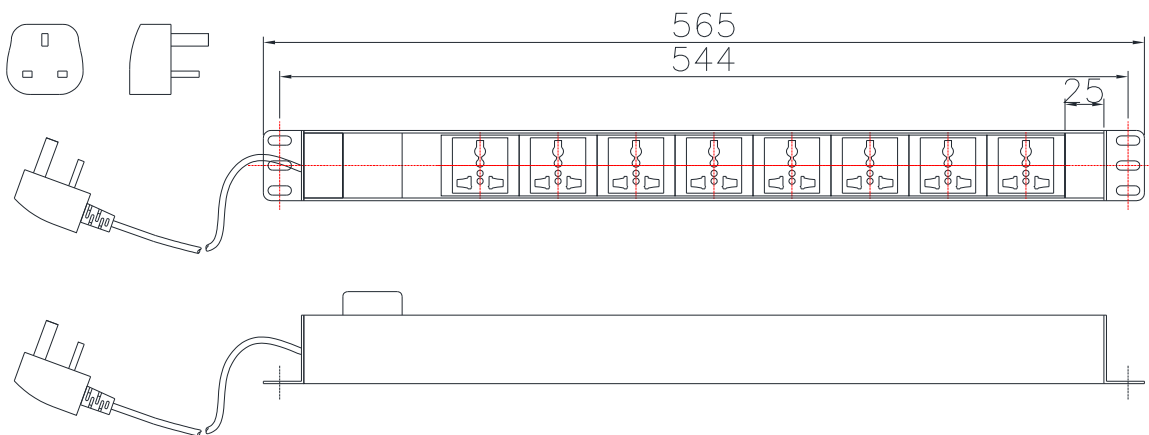

DS CODE:  
**900107**

## LS Simple™ Cabling Solution

### LS-PU8-C-EX

#### Drawing

Description	Part Numbers
Power Unit (30A-8WAY)-30A, Universal type	LS-PU8-C-EX

[mm]



Power line  
Consent type

